



Value moves the world



IL 238
EDIZ. 06/04/2017

CU3

I

**CENTRALE DI COMANDO DA
ESTERNO PER AUTOMAZIONI DI
TENDE O TAPPARELLE**

GB

**EXTERNAL CONTROL UNIT FOR
THE AUTOMATION OF AWNINGS
OR ROLLING SHUTTERS**

F

**ARMOIRE DE COMMANDE
D'EXTÉRIEUR POUR
L'AUTOMATISATION DE STORES
ET VOLETS ROULANTS**

E

**CUADRO DE MANIOBRAS
PARA TOLDOS Y PERSIANAS
DOMESTICAS CON MOTOR
TUBULAR**

D

**AUSSENSTEUERUNG ZUR
AUTOMATION VON MARKISEN
UND ROLLLÄDEN**

NL

**EXTERNE BESTURINGSEENHEID
VOOR DE AUTOMATISERING VAN
ZONWERINGEN OF ROLLUIKEN**

IMPORTANT REMARKS

- Attention: for people safety it is important to follow carefully the instructions. Keep the instructions.
- Important safety instructions for the installation. Attention: a wrong installation can cause serious accidents. Follow carefully the installation instructions.
- This device can be installed only from qualified persons and can be used only inside a tubular motor.
- As regards insulation, the features of push buttons must be suitable for electrical installations (230VAC / 120VAC).
- In order to protect the device, the installer must provide for a magnetothermal differential switch (separation among the contacts: at least 3 mm), ensuring the omnipolar sectioning from the power supply.
- In case of damages due to incorrect installation, the wiring provided together with this device can be replaced only by the manufacturer or a qualified person.
- For correct insertion of the (optional) radio receiver, please refer to the figure shown on the electrical connections page.

EU DECLARATION OF CONFORMITY

V2 S.p.A. hereby declare that CU3 products conform to the essential requirements established in the following directives:

- 2014/30/UE (EMC Directive)
- 2014/35/UE (Low Voltage Directive)
- 2014/53/UE (Radio Directive)
- ROHS2 2011/65/CE

Racconigi, lì 01/06/2016
V2 S.p.A. legal representative.
Giuseppe Pezzetto



DESCRIPTION

The unit can control one 230 VAC asynchronous motor used in systems for screens or shades.
The motor can be operated by means of push buttons connected to the terminal board, or by means of transmitters.

Main features:

- Plug-in 434.15 MHz radio receiver (OPTIONAL cod. 11B037), compatible with PROTEO / DUO / ARTEMIS / ADLER / DEV-T1 range transmitters.
- The ability to memorise up to 38 transmitters.
- The WIND, SUN and TEMPERATURE sensor levels can be adjusted using a transmitter or the LEDs mounted on the card.
- Input for WIND / MISTRAL / METEO / HURRICANE sensors.
- Input for connecting a closure command generated by an anti-theft device
- Dip switches for setting the main functions.
- Input for sun sensor ON/OFF.

TECHNICAL CHARACTERISTICS:

Power supply: 230 VAC -50 Hz
Max. motor power: 500 W
Fuse rating: 5 A
Protection level: IP55
Working temperature: 20 ÷ +60 °C

DESCRIPTION OF THE PUSH BUTTONS AND LEDS

The card has 4 push buttons + 10 LEDS:

- 1 push button key for selecting the motor (MOT)
- 1 push button key for selecting the sensor (SENS)
- 2 push button keys for selecting the sensor level (+ and -)

- 1 LED (MOT1) indicates entering programming mode
- 4 LEDS for displaying sensor status (WIND, SUN, RAIN, TEMP)
- 5 LEDS for displaying sensor levels (1, 2, 3, 4, 5)

The MOT key: for activating programming mode.

SENS key: this is used to select the sensor for the levels to be altered

The - button: this allows reducing the sensor level

The + key: this allows raising the sensor level

WORKING TIME OF MOTOR

The control unit stops the motor movement after 2 minutes: in case of limit switches malfunction this "time out" avoids the motor overheating.

ELECTRICAL CONNECTIONS

WARNING: insert the (optional) receiver as shown in the figure. Incorrect insertion can seriously damage the receiver.

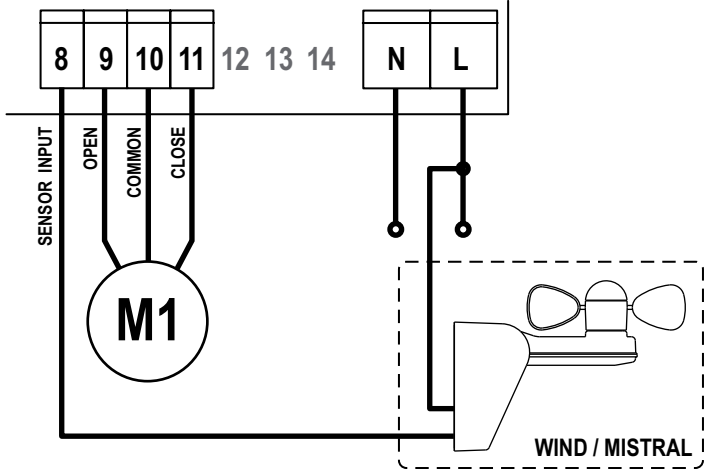
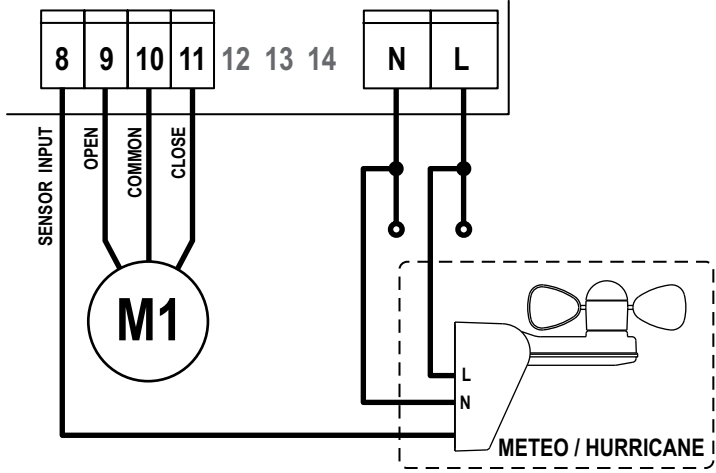
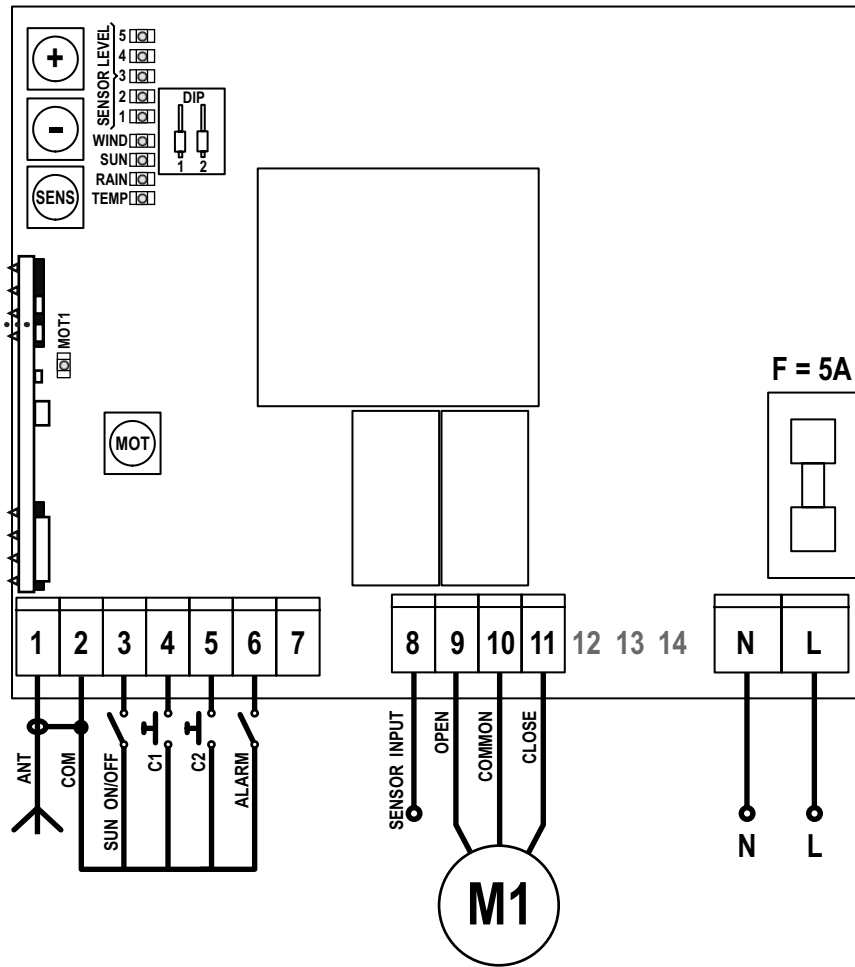

1	ANT - Antenna	
2	COM - Common (-)	
3	SUN ON/OFF - N.A. input for deactivating the sun sensor <ul style="list-style-type: none"> entry closed = sensor disabled entry open = sensor enabled 	
4	C1 - Motor 1 open	WARNING: the operation of these inputs depends on the operational logic set. See the paragraph on OPERATIONAL LOGIC
5	C2 - Motor 1 close	
6	ALARM - N.A. input for connecting a closure control provided by an antitheft device when activated. PLEASE NOTE: If antitheft device activation controls an opening phase, move this connection to terminal 7	

8	SENSOR INPUT - WIND / MISTRAL / METEO / HURRICANE sensor input
9	Motor 1 open
10	Motor 1 common
11	Motor 1 close
N	Neutral supply
L	Phase supply
7 - 12 - 13 - 14	NOT USED

SETTING THE OPERATIONAL LOGIC

By simply altering the dip-switches located on the card, it is possible for the control unit to use several different operational logic states.

The functions associated with each dip-switch are described below.

DIP		DESCRIPTION
1	ON	UP / DOWN operation
	OFF	STEP by STEP operation
2	ON	Automation blocked with antitheft device activated
	OFF	Automation manoeuvrable with antitheft device activated

UP / DOWN operation

The commands subsequent to start on inputs C1 (open) and C2 (close) cause the following sequence of operations:

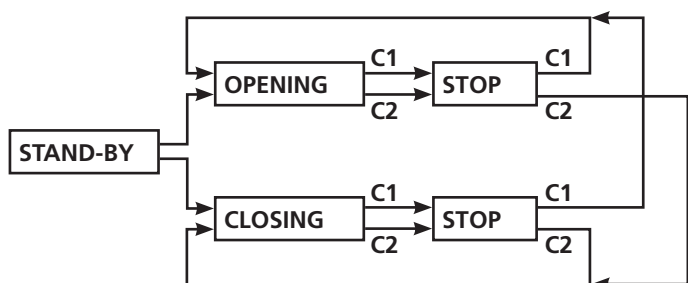

STEP by STEP operation

Successive start commands result in the following events, in order: open - stop - close - stop...

Control inputs:

C1: motor 1 control

C2: NOT USED

Automation blocked with antitheft device activated

Activation of the antitheft device causes the closure of the ALARM contact (terminal 6 or 7), causing the immediate closure of the automation system.

Until the ALARM contact is opened, the control unit does not respond to any commands and keeps the motor in the blocked state.

Automation manoeuvrable with antitheft device activated

Activation of the antitheft device causes the closure of the ALARM contact (terminal 6 or 7), causing the immediate closure of the automation system.

It is possible to control the motor, even if the ALARM contact remains closed.

SENSOR LEVELS

The sensors may be set to different levels depending on the specific needs of each installation. The sensor level may be examined by means of the 5 dedicated LEDs located on the card.

The levels shown by means of the LEDs and the corresponding real parameters are shown below (the default values are shown in boxes):

Leds ON	Wind sensor	Sun sensor	Temperature sensor
1	10 km/h	2 klux	Disabled
2	15 km/h	5 klux	0° C
3	20 km/h	10 klux	5° C
4	30 km/h	20 klux	10° C
5	40 km/h	40 klux	15° C

SETTING SENSOR LEVELS USING THE KEYS ON THE CONTROL UNIT

To alter the sensor level for motor 1, proceed as follows:

1. Press and release the MOT key: the MOT1 LED lights up
2. Press and release the SENS key until the LED relating to the desired sensor lights up.
3. The 5 dedicated LEDs show the current sensor level.
4. Press the + key to increase the level
5. Press the - key to reduce the level
6. Press the SENS key to change sensors
7. To exit programming mode, press the SENS key once after having set the temperature sensor level, or wait for 4 seconds without pressing any of the keys: the LEDs indicating the sensors and the levels are turned off.

WARNING: if no other buttons are pressed for 4 seconds, the control unit exits from programming mode.

INTERVENTION OF THE WIND SENSOR

Whenever the wind speed exceeds the set threshold value for at least 5 seconds, the control unit closes the shade and blocks the controls (no further commands accepted) for 8 minutes.

INTERVENTION OF THE SUN SENSOR

If the light intensity exceeds the set threshold value for at least 8 minutes, the control unit opens the shade.

If the light intensity drops below the set threshold value for at least 8 minutes, the control unit closes the shade. The keypad or remote control commands have priority over the sun sensor. Operation of the sun sensor may be disabled by means of a switch connected to input 3 (SUN ON/OFF).

TRANSMITTERS OF THE RANGE PROTEO / DUO

Using a transmitter of the range PROTEO / DUO it is possible changing the functions of the control unit controlling the tubular motor.

The transmitter is equipped with a 10 switches dip-switch thanks to which it is possible to change the desired functions: set on ON the switch corresponding to the function required and follow carefully the dedicated procedure.

WARNING: all the other switches have to be set on OFF

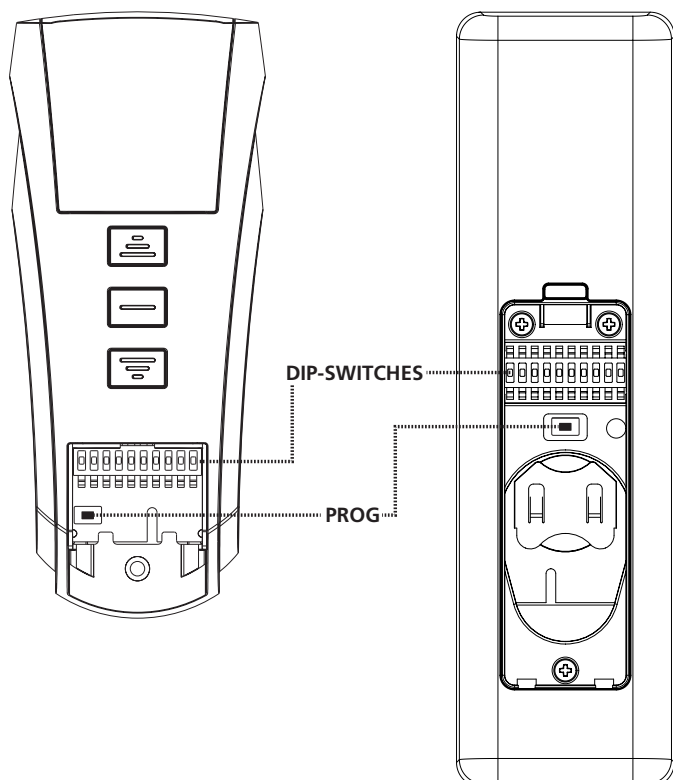

SWITCH	FUNCTION
1	Storage of the transmitters
3	Deletion of all the stored transmitters
7	Storing of the level of intervention of the wind sensor
8	Programming of the level of intervention of the sun sensor
10	Programming of the level of temperature
2 - 4 - 5 6 - 9	NOT USED

STORAGE OF THE TRANSMITTERS PROTEO / DUO

Transmitters may be memorised in two different ways:

1. By means of the MOT push-button
2. By means of the transmitter (PROG push-button)

WARNING: The first transmitter has to be memorized following the procedure (storage by push-button MOT)

STORAGE BY MEANS OF THE MOT PUSH-BUTTON

1. Set switch 1 on the transmitter to ON
2. Multichannel transmitter only: press the SELC button on the transmitter several times until the LEDs show the desired channel
3. Press and then release the MOT key on the control unit: the MOT1 LED lights up.
4. Transmit using the PROG button of the remote control device until the motor starts.
5. Release the button on the remote control device.
6. Press the UP button of the motor raised the shade, or the DOWN button if the motor lowered the shade.
7. Programming completed.

WARNING: The first transmitter memorised determines the direction of movement of the motor. If the logic is altered, it is necessary to delete all codes stored and repeat the previous steps (see paragraph DELETING TRANSMITTERS).

STORAGE BY MEANS OF THE PROG PUSH-BUTTON

To add another transmitter TX2 to the control unit it is necessary to use a remote control previously stored (TX1) and proceed as follows:

1. Multichannel transmitter only: press several times the key SELC of the transmitter TX1 until displayed the channel stored (by the leds).
2. Multichannel transmitter only: press several times the key SELC of the new transmitter TX2 until display the channel to be stored (by the leds).
3. Take the roll-up shutter to half its way with TX1.
4. Set to ON the switch 1 of the transmitter TX1.
5. Press and keep pressed for about 5 seconds the key PROG of the TX1 until the motor starts to move.
6. Release the key PROG, the motor stops.
7. Press the key UP or DOWN of the TX2: the transmitter is stored with the same logic of the TX1.

DELETING ALL TRANSMITTERS MEMORISED

Transmitters may be deleted in two different ways:

1. By means of the MOT push-button
2. By means of the transmitter (PROG push-button)

DELETING BY MEANS OF THE MOT PUSH-BUTTON

1. Remove the power supply to the control unit.
2. Press and hold the MOT key while power is restored to the control unit.
3. After 2 seconds, release the MOT key: the MOT1 LED flash for one second to indicate the delete process has been successful.

DELETING BY MEANS OF THE PROG PUSH-BUTTON

To delete all the transmitters stored on the control unit it is necessary using a remote control previously stored and proceed as follows:

1. Power only the control unit to be programmed
2. Multichannel transmitter only: press several times the button SELC on the transmitter until displayed the channel stored (by the leds)
3. Position the roll-up shutter at the mid-height.
4. Set on ON the switch 3 of the transmitter.
5. Press and keep pressed the button PROG of the transmitter until the motor moves in both the ways for 1 second, showing the end of deletion.
6. Release the button PROG and set on OFF the switch 3 of the transmitter.

To delete all the codes by means of a transmitter non-stored, proceed as follows:

1. Position the retractable at the mid-height.
2. Switch off power supply of the system.
3. Set on ON the switch 3 of a transmitter.
4. Press and keep pressed the button PROG.
5. Supply power only to the control unit on which to make the deletion: after about 1 second the motor moves in both the ways showing the correct deletion.
6. Release the button PROG and set on OFF the switch 3.

STORING OF THE LEVEL OF INTERVENTION OF THE WIND SENSOR (SWITCH 7)



WARNING: to make the awning close, the wind sensor has to detect a value higher than the set threshold value for at least 5 seconds. The automation is blocked for 8 minutes when the awning is closed because of strong wind.

To set the level of intervention of the wind sensor it is necessary to use a remote control previously stored and proceed as follows:

1. Multichannel transmitter only: press several times the button SELC of the transmitter until shown by leds the channel stored.
2. Position the roll-up shutter at the mid-height
3. Set on ON the switch 7 of the transmitter.
4. Press and keep pressed (for 5 about seconds) the button PROG of the transmitter until the motor moves jerkily in both the ways showing that it enters the storing.
5. The number of jerks made by the motor corresponds to the level currently set:
1 jerk = level 1 = 10 Km/h
2 jerks = level 2 = 15 Km/h
3 jerks = level 3 = 20 Km/h
4 jerks = level 4 = 30 Km/h (default)
5 jerks = level 5 = 40 Km/h
6. To increase the level press button UP, to decrease it press button DOWN.
7. As soon as the control unit receives the control, it shows the new level moving the motor with the corresponding number of jerks.
8. To exit the programming press STOP: the motor displays again the set level and exits.

PROGRAMMING OF THE LEVEL OF INTERVENTION OF THE SUN SENSOR (SWITCH 8)

⚠ WARNING: to make the awning open the sun sensor has to detect a value higher than the set threshold value for at least 8 minutes. To make it close, the sensor has to detect a value lower than the set threshold value for at least 8 minutes. Interruptions of light (due to clouds) shorter than a minute are not detected, while the 8-minute timer is set at zero when longer than one minute.

To set the level of intervention of the sun sensor it is necessary to use a remote control previously stored and proceed as follows:

1. Multichannel transmitter only: press several times the button SELC of the transmitter until shown by leds the channel stored.
2. Position the roll-up shutter at the mid-height
3. Set on ON the switch 8 of the transmitter.
4. Press and keep pressed (for 5 about seconds) the button PROG of the transmitter until the motor moves jerkily in both the ways showing that it enters the storing.
5. The number of jerks made by the motor corresponds to the level currently set:
1 jerk = level 1 = 2 Klux
2 jerks = level 2 = 5 Klux
3 jerks = level 3 = 10 Klux (default)
4 jerks = level 4 = 20 Klux
5 jerks = level 5 = 40 Klux
6. To increase the level press button UP, to decrease it press button DOWN.
7. As soon as the control unit receives the control, it shows the new level moving the motor with the corresponding number of jerks.
8. To exit the programming press STOP: the motor displays again the set level and exits.
9. Set on OFF the switch 8

To disabling the sun sensor proceed as follows:

1. Multichannel transmitter only: press several times the button SELC of the transmitter until shown by leds the channel stored.
2. Position the roll-up shutter at the mid-height
3. Press the key STOP and immediately after the key DOWN (keeping pressed the key STOP) until the motor moves for about one second in both the ways, indicating that the procedure has been finished.

To enable again the sun sensor it is enough to repeat the procedure above using the key UP instead of the key DOWN.

PROGRAMMING OF THE LEVEL OF TEMPERATURE (SWITCH 10)

The temperature can be set on 5 levels, under which the sun sensor must not open the awning, even if the light intensity has exceeded the level set by switch 8.

This function is particularly useful in Countries with wintry weather, where sunny but very cold days are frequent. In this case, it is not necessary to open the awnings, to let the sun warm the inner rooms.

To set the level of temperature it is necessary to use a remote control previously stored and proceed as follows:

1. Multichannel transmitter only: press several times the button SELC of the transmitter until shown by leds the channel stored.
2. Position the roll-up shutter at the mid-height
3. Set on ON the switch 10 of the transmitter.
4. Press and keep pressed (for 5 about seconds) the button PROG of the transmitter until the motor moves jerkily in both the ways showing that it enters the storing.
5. The number of jerks made by the motor corresponds to the level currently set:
1 jerk = level 1 = sensor disabled (default)
2 jerks = level 2 = 0°C
3 jerks = level 3 = 5°C
4 jerks = level 4 = 10°C
5 jerks = level 5 = 15°C
6. To increase the level press button UP, to decrease it press button DOWN.
7. As soon as the control unit receives the control, it shows the new level moving the motor with the corresponding number of jerks.
8. To exit the programming press STOP: the motor displays again the set level and exits.
9. Set on OFF the switch 10

ARTEMIS SERIES TRANSMITTERS

Using a transmitter of the ARTEMIS series you can change the functions of the control unit that drives the tubular motor.

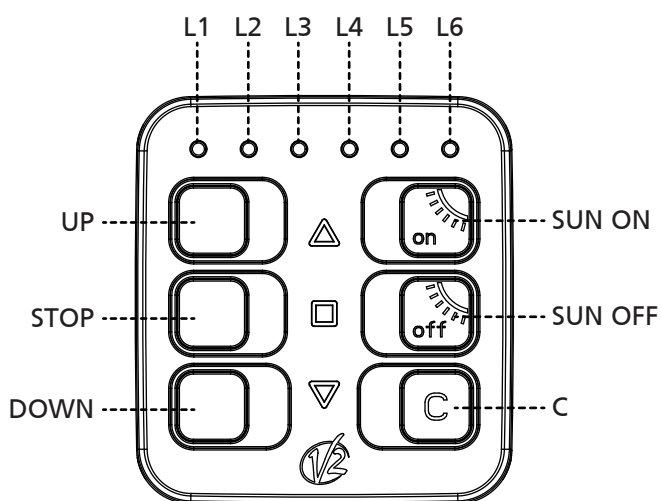
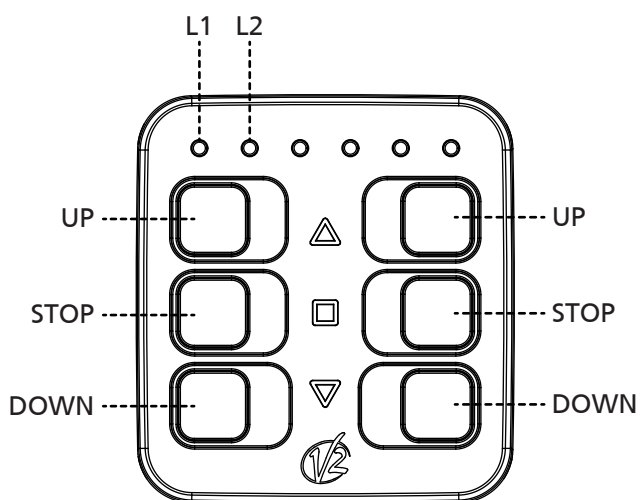
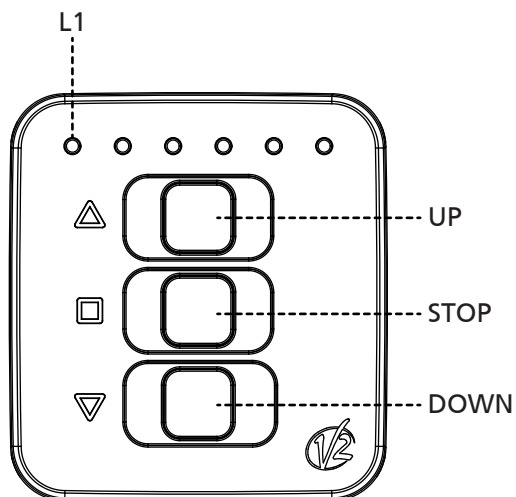

FAST PROGRAMMING

RAPID TRANSMITTER DATA STORAGE

CAUTION: The data storage of the first transmitter determines the direction of motion of the motor.

CAUTION: If the awning has a casing carry out the data storage of the first remote control by following the procedure "TRANSMITTER DATA STORAGE"

To store your remote controls on a virgin control unit which drives a shutter or an awning (WITHOUT casing) proceed as follows:

1. Supply power only to the control unit to be programmed
2. Activate the programming by following one of these procedures

Artemis with 1 channel:

- Press and hold down the UP+DOWN keys until the motor starts to move in one direction

Artemis with 2 channels:

- Press the UP+DOWN keys of one of the two channels until the motor starts to move in one direction

Artemis with 6 channels:

- Select the channel to be programmed with the C key
- Press the UP+DOWN keys until the motor starts to move in one direction

3. Release the keys: the motor stops
4. Press the UP or DOWN keys according to the direction in which the roll-up shutter was moving before it stopped:
 - if the roll-up shutter was being raised press the UP key; direction obtained: the UP key raises the roll-up shutter, the DOWN key lowers the roll-up shutter
 - if the roll-up shutter was being lowered press the DOWN key; direction obtained: the DOWN key lowers the roll-up shutter, the UP key raises the roll-up shutter.
5. Programming is complete

To add additional remote controls, proceed as follows:

6. Press and hold down the UP+DOWN keys of a remote control which has already been programmed until the motor starts to move in one direction
7. Release the keys: the motor stops
8. Press the UP or DOWN key of the new remote control

ACTIVATION OF THE SUN SENSOR ON A CONTROL UNIT

Press and hold down the STOP+UP keys until the motor confirms the operation by moving in both directions.

DEACTIVATION OF THE SUN SENSOR ON A CONTROL UNIT

Press and hold down the STOP+DOWN keys until the motor confirms the operation by moving in both directions.

ADVANCED PROGRAMMING

To perform ADVANCED programming it is necessary to activate the programming by following one of the following procedures.

ACTIVATION OF PROGRAMMING

Artemis with 1 channel:

- Press the STOP+UP+DOWN keys until the 6 LEDs light up
- Release the keys: the programming remains active for 30 seconds during which the LEDs flash

Artemis with 2 channels:

- Press the STOP+UP+DOWN keys of the channel to be programmed until the LEDs light up
- Release the keys: the programming remains active for 30 seconds during which the LEDs flash

Artemis with 6 channels:

- Select the channel to be programmed with the C key
- Press the STOP+UP+DOWN keys until the 6 LEDs light up
- Release the keys: the programming remains active for 30 seconds during which the LEDs flash

Note: this procedure will be the same for the programming of all functions and will not be repeated in the following paragraphs

List of available functions:

1. Transmitter memorization and sunshade/roll-up shutter mode selection
2. Deletion of all memorized transmitters
3. Programming the wind sensor intervention threshold
4. Programming the sun sensor intervention threshold
5. Programming the temperature level

TRANSMITTER DATA STORAGE



CAUTION: The data storage of the first transmitter determines the direction of motion of the motor.

To store a transmitter on a virgin control unit proceed as follows:

1. Supply power only to the control unit to be programmed
2. Activate the ARTEMIS programming
3. Press the UP or DOWN key until the LED 1 lights up with solid light and the others flash.
4. Press the UP+DOWN keys until the motor starts to move in one direction
5. Release the keys, the motor stops
6. Press the UP or DOWN keys according to the direction in which the roll-up shutter was moving before it stopped:
 - if the roll-up shutter was being raised press the UP key; direction obtained: the UP key raises the roll-up shutter, the DOWN key lowers the roll-up shutter
 - if the roll-up shutter was being lowered press the DOWN key; direction obtained: the DOWN key lowers the roll-up shutter, the UP key raises the roll-up shutter.
7. To exit the programming mode press the STOP key
8. Try to operate the roll-up shutter and verify that it works according to the logic described above. If the logic is reversed it is necessary to delete all the codes stored (see "DELETION OF ALL MEMORIZED TRANSMITTERS") and repeat the steps above.

To add other remote controls follow steps 6, 7, 8 of the procedure "RAPID TRANSMITTER DATA STORAGE"

DELETION OF ALL MEMORIZED TRANSMITTERS

To delete all codes stored with an Artemis proceed as follows:

1. Supply power only to the control unit to be programmed
2. Activate the ARTEMIS programming
3. Press the UP or DOWN keys until the LED 3 lights up with solid light and the others flash
4. Press and hold down the UP+DOWN keys until the motor moves in both directions which confirms the correct deletion of the codes.
5. Release the keys
6. To exit the programming mode press the STOP key

To delete all codes NOT stored with an Artemis proceed as follows:

1. Cut the power to the motor on which to delete all the codes
2. Activate the ARTEMIS programming
3. Press the UP or DOWN keys until the LED 3 lights up with solid light
4. Press and hold down the UP+DOWN keys
5. Power the motor and wait until the motor moves in both directions which confirms the correct deletions of the codes
6. To exit the programming mode press the STOP key

PROGRAMMING THE WIND SENSOR INTERVENTION THRESHOLD



CAUTION: to trigger the closing of the sunshade, the wind sensor must detect a value greater than the set threshold for at least 5 seconds. The closure of the sunshade caused by strong wind stops the automated system for 8 minutes.

To set the wind sensor intervention threshold, it is necessary to use a remote control previously stored and proceed as follows:

1. Supply power only to the control unit to be programmed
2. Activate the ARTEMIS programming
3. Press the UP or DOWN keys until the LEDs 1+2 light up with solid light and the others flash
4. Press the UP+DOWN keys until the motor moves in jerks which confirms it is entering the programming phase.
The number of jerks made by the motor corresponds to the level currently set:
 - 1 jerk = level 1 = 10 Km/h
 - 2 jerks = level 2 = 15 Km/h
 - 3 jerks = level 3 = 20 Km/h
 - 4 jerks = level 4 = 30 km/h (default value)
 - 5 jerks = level 5 = 40 Km/h
5. Release the keys
6. To increase the level press the UP key and to decrease it press the DOWN key, as soon as the control unit receives the command, it shows the new level by operating the motor with a corresponding number of jerks
7. When the desired value is reached, press the STOP button: the control unit will show the set value again to confirm
8. To exit the programming mode press the STOP key

PROGRAMMING THE SUN SENSOR INTERVENTION THRESHOLD



CAUTION: to trigger the opening of the sunshade, the sun sensor must detect a value greater than the set threshold for at least 8 minutes. To trigger the closing, the sensor must detect a value below the set threshold for at least 8 minutes. Interruptions of light (due to clouds) shorter than 1 minute are not detected, while if they exceed 1 minute, the 8-minute timer is reset.

To set the sun sensor intervention threshold, it is necessary to use a remote control previously stored and proceed as follows:

1. Supply power only to the control unit to be programmed
2. Activate the ARTEMIS programming
3. Press the UP or DOWN keys until the LEDs 1+2 light up with solid light and the others flash

4. Press the UP+DOWN keys until the motor moves in jerks which confirms it is entering the programming phase.
The number of jerks made by the motor corresponds to the level currently set:
 - 1 jerk = level 1 = 2 klux
 - 2 jerks = level 2 = 5 klux
 - 3 jerks = level 3 = 10 klux (default value)
 - 4 jerks = level 4 = 20 klux
 - 5 jerks = level 5 = 40 klux
5. Release the keys
6. To increase the level press the UP key and to decrease it press the DOWN key, as soon as the control unit receives the command, it shows the new level by operating the motor with a corresponding number of jerks
7. When the desired value is reached, press the STOP button: the control unit will show the set value again to confirm
8. To exit the programming mode press the STOP key

PROGRAMMING THE TEMPERATURE LEVEL

This function allows you to adjust the temperature to 5 levels, below which the sun sensor must not open the sunshade, even if the light intensity exceeds the level set.

This feature is particularly useful in countries with a cold climate, where sunny days are frequent but very cold. In these situations, it is not necessary to open the sunshade that would prevent the sunlight from heating the indoor environment.

To set the temperature level, it is necessary to use a remote control previously stored and proceed as follows:

1. Supply power only to the control unit to be programmed
2. Activate the ARTEMIS programming
3. Press the UP or DOWN keys until the LEDs 1+2 light up with solid light and the others flash
4. Press the UP+DOWN keys until the motor moves in jerks which confirms it is entering the programming phase.
The number of jerks made by the motor corresponds to the level currently set:
 - 1 click = level 1 = sensor disabled (default value)
 - 2 clicks = level 2 = 0°C
 - 3 clicks = level 3 = 5°C
 - 4 clicks = level 4 = 10°C
 - 5 clicks = level 5 = 15°C
5. Release the keys
6. To increase the level press the UP key and to decrease it press the DOWN key, as soon as the control unit receives the command, it shows the new level by operating the motor with a corresponding number of jerks
7. When the desired value is reached, press the STOP button: the control unit will show the set value again to confirm
8. To exit the programming mode press the STOP key

TRANSMITTERS OF THE RANGE ADLER

Using a transmitter of the range ADLER it is possible changing the functions of the control unit controlling the tubular motor.

ADVANCED PROGRAMMING

To perform ADVANCED programming it is necessary to remove the cover plate of the remote control and carefully follow the dedicated procedures for the various functions.

Each function can be selected by entering a code during the programming procedure; following is a summary table of the functions with their relative programming codes.

CODE			FUNCTION
A	B	C	
12	11	11	Storage of the transmitters
12	11	13	Deletion of all the stored transmitters
12	11	17	Storing of the level of intervention of the wind sensor
12	11	18	Programming of the level of intervention of the sun sensor
12	11	21	Programming of the level of temperature

A: Code to activate programming

B: Indicates channel 1 of the remote control; for channel 2 the number is 12, for channel 3 the number is 13, etc. up to channel 6

C: Code of the function to be programmed

The pictures that follow include references to the buttons and the LEDs used during programming.

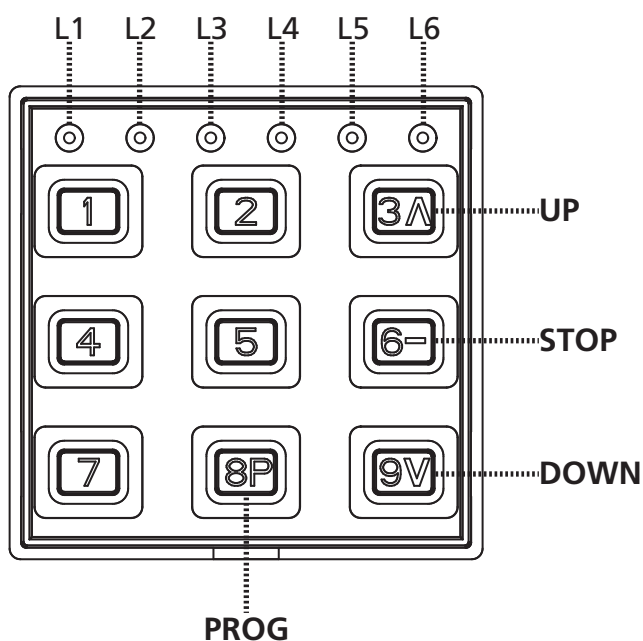

STORAGE OF THE TRANSMITTERS ADLER

Transmitters may be memorised in two different ways:

1. By means of the MOT push-button
2. By means of the transmitter (PROG push-button)

! WARNING: The first transmitter has to be memorized following the procedure (storage by push-button MOT)

STORAGE BY MEANS OF THE MOT PUSH-BUTTON

1. Power only the control unit to be programmed
2. Activate ADLER programming by holding down buttons 4 and 6 until the 6 LEDs turn on
3. Release the buttons and enter the code 12 **11** 11
The two highlighted digits indicate the remote control channel to be recorded; for channel 1 the digits are **11**, for channel 2 the digits are **12**, for channel 3 the digits are **13**, etc up to channel 6. Once the codes have been entered, the LED of the selected channel will blink for 2 minutes after which it exits programming.
4. Press and then release the MOT key on the control unit: the MOT1 LED lights up.
5. Press and hold down the PROG button of the TX1 remote control until the motor starts to move in a direction
6. Release the PROG button: the motor will stop
7. Press the UP button of the motor raised the shade, or the DOWN button if the motor lowered the shade.
8. Programming completed.

! WARNING: The first transmitter memorised determines the direction of movement of the motor. If the logic is altered, it is necessary to delete all codes stored and repeat the previous steps (see paragraph DELETING TRANSMITTERS).

STORAGE BY MEANS OF THE PROG PUSH-BUTTON

To add other remote controls, proceed as follows:

1. Press and hold down the UP and DOWN buttons of a remote control that is already recorded until the motor starts to move in a direction
2. Release the buttons: the motor will stop
3. Press the UP or DOWN button on the new remote control

DELETING ALL TRANSMITTERS MEMORISED

Transmitters may be deleted in two different ways:

1. By means of the MOT push-button
2. By means of the transmitter (PROG push-button)

DELETING BY MEANS OF THE MOT PUSH-BUTTON

1. Remove the power supply to the control unit.
2. Press and hold the MOT key while power is restored to the control unit.
3. After 2 seconds, release the MOT key: the MOT1 LED flash for one second to indicate the delete process has been successful.

DELETING BY MEANS OF THE PROG PUSH-BUTTON

To delete all the transmitters stored on the control unit it is necessary using a remote control previously stored and proceed as follows:

1. Power only the control unit to be programmed
2. Activate ADLER programming by holding down buttons 4 and 6 until the 6 LEDs turn on
3. Release the buttons and enter the code 12 **11** 13
The two highlighted digits indicate the remote control channel recorded in the control unit; for channel 1 the digits are **11**, for channel 2 the digits are **12**, for channel 3 the digits are **13**, etc up to channel 6. Once the codes have been entered, the LED of the selected channel will blink for 2 minutes after which it exits programming.
4. Position the roll-up shutter at mid-height using UP-STOP-DOWN
5. Press and hold down the PROG button of the remote control until the motor starts to move in a direction
6. Release the PROG button: the motor will stop
7. To exit the programming mode, wait for the led to switch off or press key 1 to exit immediately.

To delete all the codes by means of a transmitter non-stored, proceed as follows:

1. Switch off power supply of the system.
2. Activate ADLER programming by holding down buttons 4 and 6 until the 6 LEDs turn on
3. Release the buttons and enter the code 12 **11** 13
4. Press and keep pressed the button PROG
5. Power all control units where the deletion will be performed
6. Hold down the PROG button until the motor starts to move for about 1/2 second in both directions, indicating that the deletion has been completed.
7. Release the PROG button: the motor will stop
8. To exit the programming mode, wait for the led to switch off or press key 1 to exit immediately.

STORING OF THE LEVEL OF INTERVENTION OF THE WIND SENSOR



WARNING: to make the awning close, the wind sensor has to detect a value higher than the set threshold value for at least 5 seconds. The automation is blocked for 8 minutes when the awning is closed because of strong wind.

To set the level of intervention of the wind sensor it is necessary to use a remote control previously stored and proceed as follows:

1. Activate ADLER programming by holding down buttons 4 and 6 until the 6 LEDs turn on
2. Release the buttons and enter the code 12 **11** 17
The two highlighted digits indicate the remote control channel recorded in the control unit; for channel 1 the digits are **11**, for channel 2 the digits are **12**, for channel 3 the digits are **13**, etc up to channel 6. Once the codes have been entered, the LED of the selected channel will blink for 2 minutes after which it exits programming.
3. Press and keep pressed (for 5 about seconds) the button PROG of the transmitter until the motor moves jerkily in both the ways showing that it enters the storing.
4. The number of jerks made by the motor corresponds to the level currently set:
1 jerk = level 1 = 10 Km/h
2 jerks = level 2 = 15 Km/h
3 jerks = level 3 = 20 Km/h
4 jerks = level 4 = 30 Km/h (default)
5 jerks = level 5 = 40 Km/h
5. Release the key PROG
6. To increase the level press button UP, to decrease it press button DOWN.
7. As soon as the control unit receives the control, it shows the new level moving the motor with the corresponding number of jerks.
8. To exit the programming press STOP: the motor displays again the set level and exits.
9. To exit the programming mode, wait for the led to switch off or press key 1 to exit immediately.

PROGRAMMING OF THE LEVEL OF INTERVENTION OF THE SUN SENSOR

 **WARNING:** to make the awning open the sun sensor has to detect a value higher than the set threshold value for at least 8 minutes. To make it close, the sensor has to detect a value lower than the set threshold value for at least 8 minutes. Interruptions of light (due to clouds) shorter than a minute are not detected, while the 8-minute timer is set at zero when longer than one minute.

To set the level of intervention of the sun sensor it is necessary to use a remote control previously stored and proceed as follows:

1. Activate ADLER programming by holding down buttons 4 and 6 until the 6 LEDs turn on
2. Release the buttons and enter the code 12 **11** 18
The two highlighted digits indicate the remote control channel recorded in the control unit; for channel 1 the digits are 11, for channel 2 the digits are **12**, for channel 3 the digits are **13**, etc up to channel 6. Once the codes have been entered, the LED of the selected channel will blink for 2 minutes after which it exits programming.
3. Press and keep pressed (for 5 about seconds) the button PROG of the transmitter until the motor moves jerkily in both the ways showing that it enters the storing.
4. The number of jerks made by the motor corresponds to the level currently set:
1 jerk = level 1 = 2 Klux
2 jerks = level 2 = 5 Klux
3 jerks = level 3 = 10 Klux (default)
4 jerks = level 4 = 20 Klux
5 jerks = level 5 = 40 Klux
5. Release the key PROG
6. To increase the level press button UP, to decrease it press button DOWN.
7. As soon as the control unit receives the control, it shows the new level moving the motor with the corresponding number of jerks.
8. To exit the programming press STOP: the motor displays again the set level and exits.
9. To exit the programming mode, wait for the led to switch off or press key 1 to exit immediately.

PROGRAMMING OF THE LEVEL OF TEMPERATURE

The temperature can be set on 5 levels, under which the sun sensor must not open the awning, even if the light intensity has exceeded the level set.

This function is particularly useful in Countries with wintry weather, where sunny but very cold days are frequent. In this case, it is not necessary to open the awnings, to let the sun warm the inner rooms.

To set the level of temperature it is necessary to use a remote control previously stored and proceed as follows:

1. Activate ADLER programming by holding down buttons 4 and 6 until the 6 LEDs turn on
2. Release the buttons and enter the code 12 11 21
The two highlighted digits indicate the remote control channel recorded in the control unit; for channel 1 the digits are 11, for channel 2 the digits are 12, for channel 3 the digits are 13, etc up to channel 6. Once the codes have been entered, the LED of the selected channel will blink for 2 minutes after which it exits programming.
3. Press and keep pressed (for 5 about seconds) the button PROG of the transmitter until the motor moves jerkily in both the ways showing that it enters the storing.
4. The number of jerks made by the motor corresponds to the level currently set:
1 jerk = level 1 = sensor disabled (default)
2 jerks = level 2 = 0°C
3 jerks = level 3 = 5°C
4 jerks = level 4 = 10°C
5 jerks = level 5 = 15°C
5. Release the key PROG
6. To increase the level press button UP, to decrease it press button DOWN.
7. As soon as the control unit receives the control, it shows the new level moving the motor with the corresponding number of jerks.
8. To exit the programming press STOP: the motor displays again the set level and exits.
9. To exit the programming mode, wait for the led to switch off or press key 1 to exit immediately.

TRANSMITTERS OF THE RANGE DEV-T1

Using a DEV-T1 series transmitter it is possible to activate the transmitter storage.

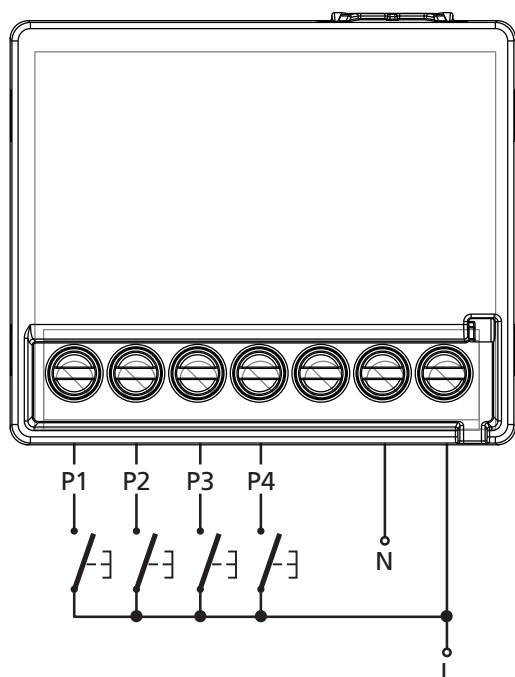

P1	UP button input
P2	STOP button input
P3	DOWN button input
P4	Code storage stage activated
N	Power supply neutral
L	Power supply phase

Pressing the three buttons in combination allows to activate the following functions on the control unit:

P2 + P1 - Sun sensor activated

P2 + P3 - Sun sensor disabled

P1 + P3 - STOP command

NOTE: you must hold the buttons pressed until the control unit signals it has received the command by running the motor or activating the relays.

STORAGE OF THE TRANSMITTERS DEV-T1

Transmitters may be memorised in two different ways:

1. By means of the MOT push-button
2. By means of the transmitter (P4 push-button)

⚠ WARNING: The first transmitter has to be memorized following the procedure (storage by push-button MOT)

STORAGE BY MEANS OF THE MOT PUSH-BUTTON

1. Press and then release the MOT key on the control unit: the MOT1 LED lights up.
2. Transmit using the P4 button of the remote control device until the motor starts.
3. Release the button on the remote control device.
4. Press the UP button of the motor raised the shade, or the DOWN button if the motor lowered the shade.
5. Programming completed.

⚠ WARNING: The first transmitter memorised determines the direction of movement of the motor. If the logic is altered, it is necessary to delete all codes stored and repeat the previous steps (see paragraph DELETING TRANSMITTERS).

STORAGE BY MEANS OF THE P4 PUSH-BUTTON

To add another transmitter TX2 to the control unit it is necessary to use a DEV-T1 previously stored (TX1) and proceed as follows:

1. Press and keep pressed for about 5 seconds the key P4 of the TX1 until the motor starts to move.
2. Release the key P4, the motor stops.
3. Press the key UP or DOWN of the TX2: the transmitter is stored with the same logic of the TX1.

DELETING ALL TRANSMITTERS MEMORISED

1. Remove the power supply to the control unit.
2. Press and hold the MOT key while power is restored to the control unit.
3. After 2 seconds, release the MOT key: the MOT1 LED flash for one second to indicate the delete process has been successful.